

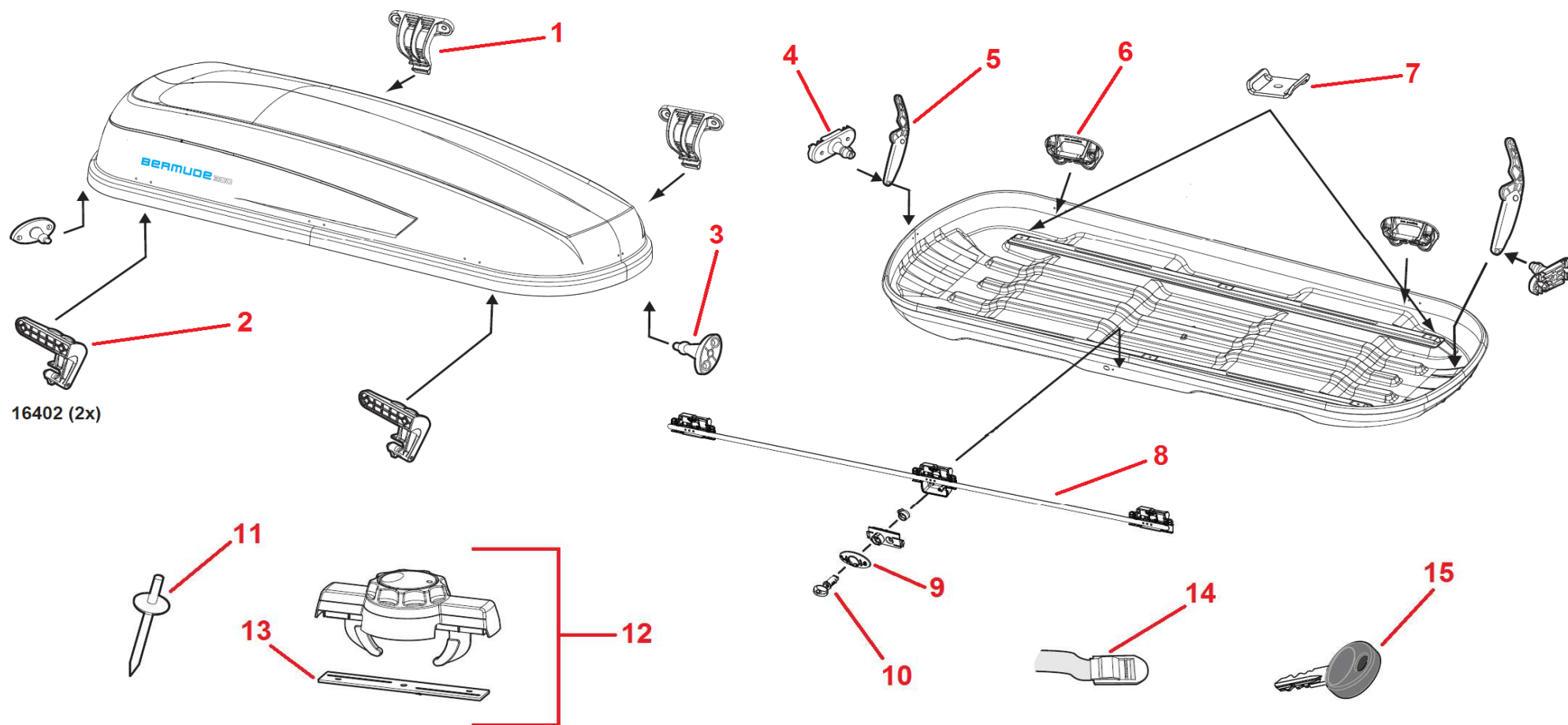













# Vue technique coffre de toit Bermude 300

ART : 2180743



INDEX	CODE 6	DESIGNATION	PHOTO	INDEX	CODE 6	DESIGNATION	PHOTO
1	318045	CHARNIERE		2	281474	CROCHET	
3	285528	FIXATION SUP. VERIN		4	281421	FIXATION INF. VERIN	
5	241632	VERIN COMPAS		6	318046	FIXATION CHARNIERE	
7	346801	PASSE SANGLE		8	769360	BARRE SERRURE CENTRALISEE	
9	890895	CONTOUR DE BARILLET		10	769363	BARILLET	
11	810036	RIVET		12	346799	MOLETTE MASTERFIT	
13	346800	JOINT MOLETTE MASTERFIT		14	699679	SANGLE	
15	CLES	Demande de reproduction de clés sur le portail NEXT					