

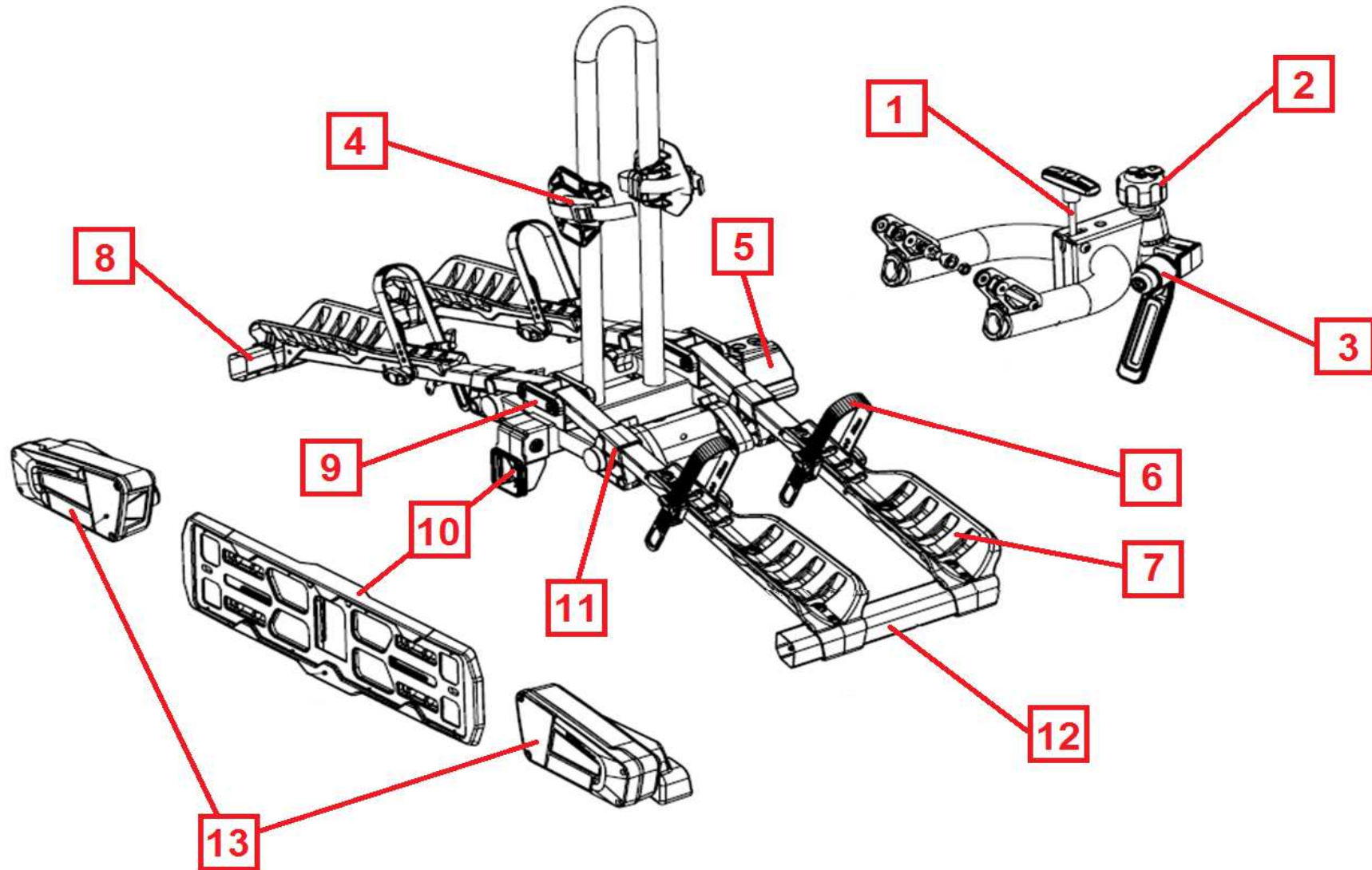















# Vue technique RAPIDBIKE 2P/3P/4P FLEX (2019)

63433 - 63435 - 63436

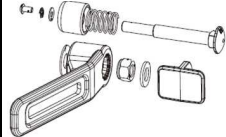

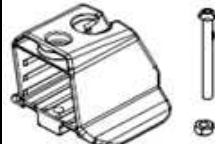
INDEX	CODE ART.	DESIGNATION		INDEX	CODE ART.	DESIGNATION	
1	75442	Levier de blocage		2	75428	Molette avec clés K001	
2	75429	Molette avec clés K002		2	75430	Molette avec clés K003	
2	75431	Molette avec clés K004		2	75432	Molette avec clés K005	
2	75433	Molette avec clés K006		2	75434	Molette avec clés K007	
2	75435	Molette avec clés K008		2	75436	Molette avec clés K009	
2	75437	Molette avec clés K010		3	75438	Levier de serrage	
4	75447	Clip d'attache		5	75445	Embout de plateforme	

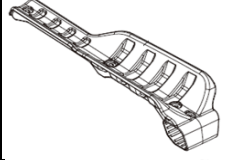
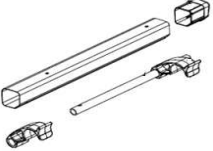
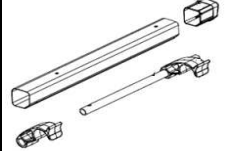
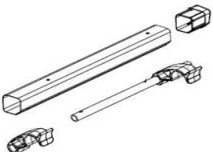
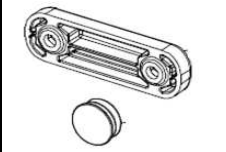
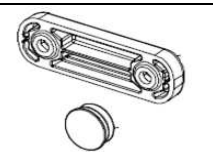
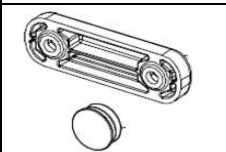
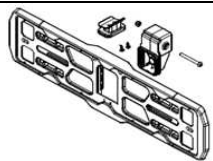
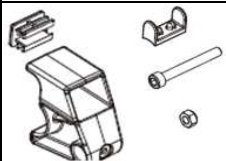
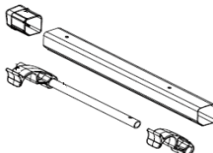
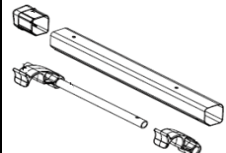
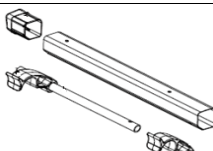
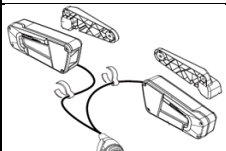
INDEX	CODE ART.	DESIGNATION		INDEX	CODE ART.	DESIGNATION	
6	75460	Sangle de roue		7	75451	Support de roue	
8	74279	Ensemble tube gauche (2P FLEX)		8	74280	Ensemble tube gauche (3P FLEX)	
8	75421	Ensemble tube gauche (4P FLEX)		9	74276	Jeu de caches et bouchons (2P FLEX)	
9	74277	Jeu de caches et bouchons (3P FLEX)		9	74278	Jeu de caches et bouchons (4P FLEX)	
10	75425	Support de plaque		11	75454	Crochet de fixation	
12	75422	Ensemble tube droit (2P FLEX)		12	75423	Ensemble tube droit (3P FLEX)	
12	75424	Ensemble tube droit (4P FLEX)		13	75461	Ensemble feux arrières (2P FLEX)	

INDEX	CODE ART.	DESIGNATION		INDEX	CODE ART.	DESIGNATION	
13	75462	Ensemble feux arrières (3P/4P FLEX)	