

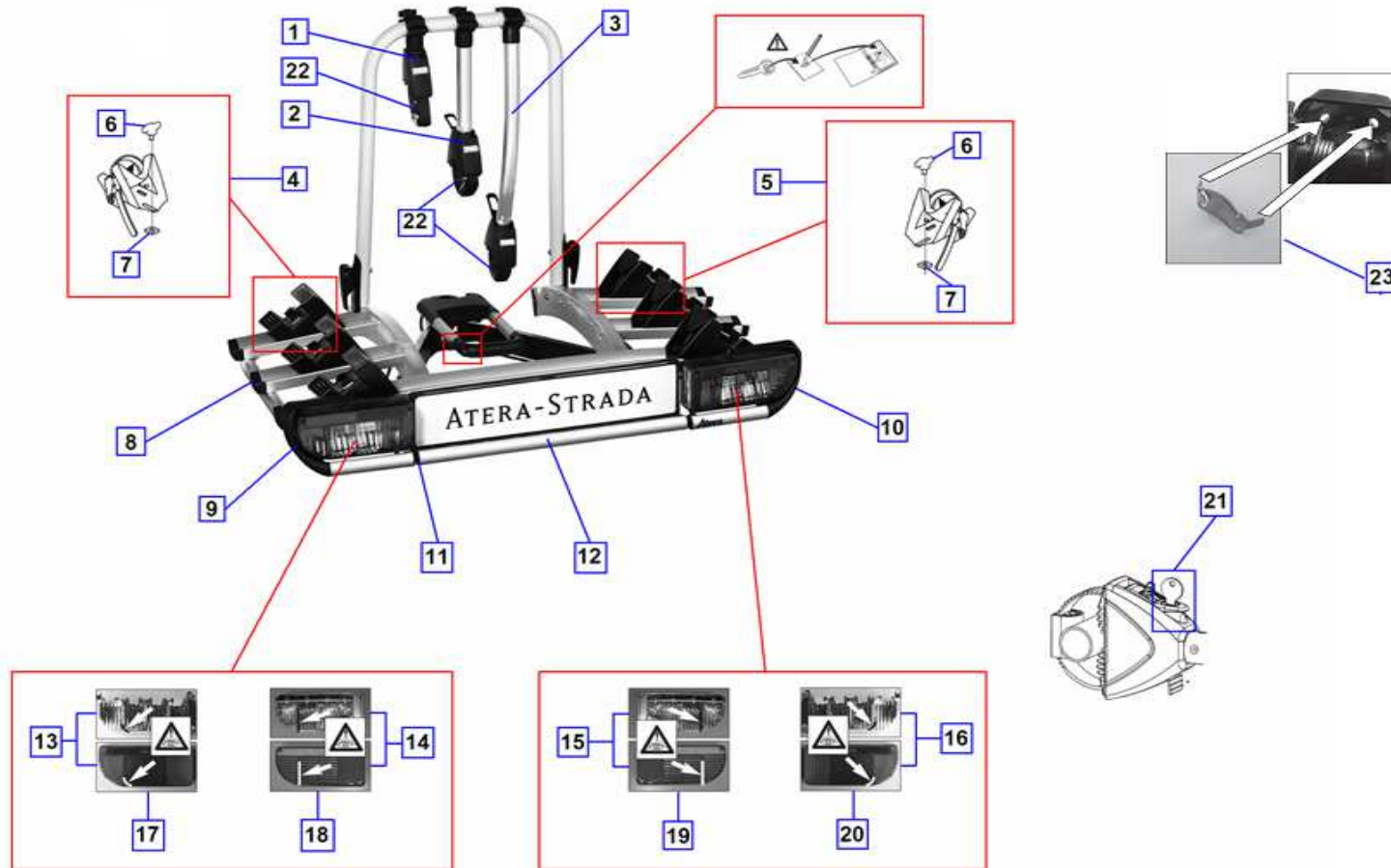









Vue technique porte-vélos Strada 3 vélos

Code: 473106





INDEX	CODE 6	DESIGNATION	PHOTO	INDEX	CODE 6	DESIGNATION	PHOTO
1	495641	PETIT BRAS SANS SERRURE		2	495642	BRAS MOYEN SANS SERRURE	
3	495643	GRAND BRAS SANS SERRURE		4	495664	ATTACHE DE ROUE GAUCHE	
5	495665	ATTACHE DE ROUE DROITE		6	495653	VIS A AILETTES	
7	495656	ECROU CARRE M8-20x20x5		8	495652	EMBOUT DE RAIL	
9	495630	PROTECTION FEU GAUCHE		10	495631	PROTECTION FEU DROIT	
11	495651	EMBOUT DE BARRE PEDALE		12	495659	BARRE PEDALE	
13	495637	CAPOT FEU GAUCHE + REFLECTEUR TYPE B		14	495632	CAPOT FEU GAUCHE + REFLECTEUR TYPE A	

INDEX	CODE 6	DESIGNATION	PHOTO	INDEX	CODE 6	DESIGNATION	PHOTO
15	495634	CAPOT FEU DROIT + REFLECTEUR TYPE A		16	495638	CAPOT FEU DROIT + REFLECTEUR TYPE B	
17	495639	CAPOT FEU GAUCHE TYPE B		18		CAPOT FEU GAUCHE TYPE A (EPUISE FOURNISSEUR)	
19	495636	CAPOT FEU DROIT TYPE A		20	495640	CAPOT FEU DROIT TYPE B	
21	495668	4 BARILLETS + 2 CLES		21	495669	8 BARILLETS + 2 CLES	
22	754394	SANGLE D'ATTACHE		23	2198259	REDUCTEUR DE JEU ATTELAGE	