

Kit 1170

LADA 110, 4-dr Sedan, 96-07

LADA 112, 5-dr Hatchback, 00-

480R
754

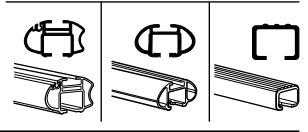
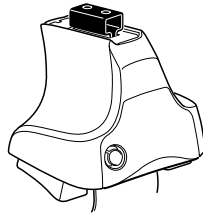

480

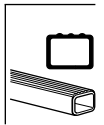
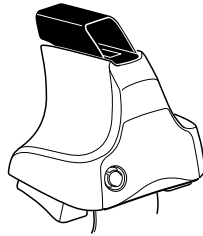

750

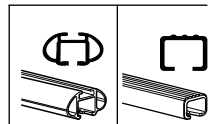
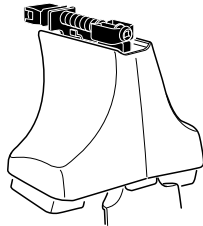

x2 x2 x2 x4	x2	x2 x2 x4 x4	x2 x2	x2

335 x 4

16 x 4

x 1

Kit





1

2

	X
LADA 110, 4-dr Sedan, 96-07	22,5
LADA 112, 5-dr Hatchback, 00-	22,5

1

2

	Y
LADA 110, 4-dr Sedan, 96-07	20
LADA 112, 5-dr Hatchback, 00-	20

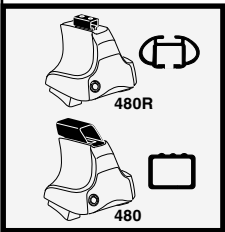

1

2

	X inch	X mm
LADA 110, 4-dr Sedan, 96-07	34 1/2"	876 mm
LADA 112, 5-dr Hatchback, 00-	34 1/2"	876 mm

1

2

	Y inch	Y mm
LADA 110, 4-dr Sedan, 96-07	33 1/2"	851 mm
LADA 112, 5-dr Hatchback, 00-	33 1/2"	851 mm

4

LADA 110, 4-dr Sedan, 96-07
LADA 112, 5-dr Hatchback, 00-

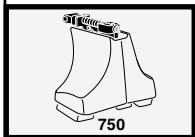
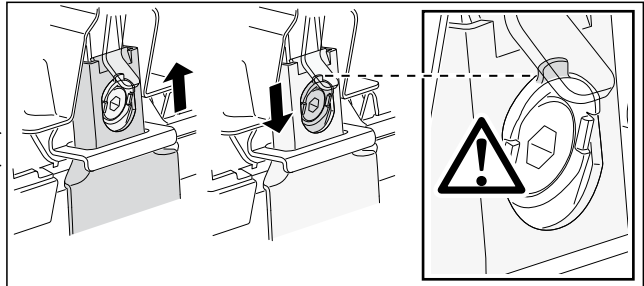
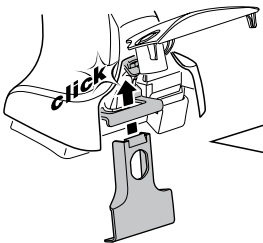
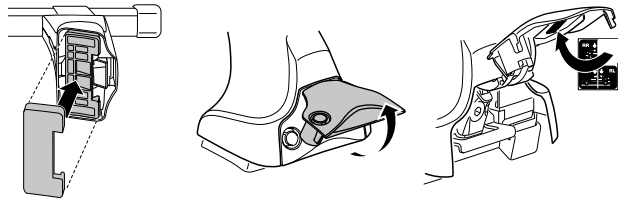
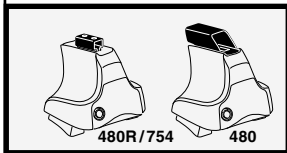
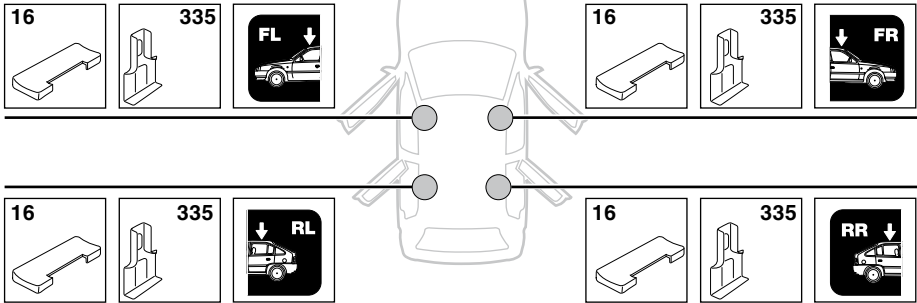

5



	X mm	Y mm	X inch	Y inch
LADA 110, 4-dr Sedan, 96-07	220 mm	700 mm	8 5/8"	27 1/2"
LADA 112, 5-dr Hatchback, 00-	220 mm	700 mm	8 5/8"	27 1/2"

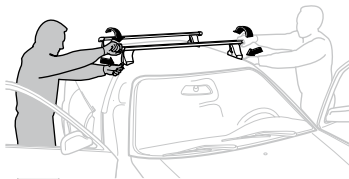
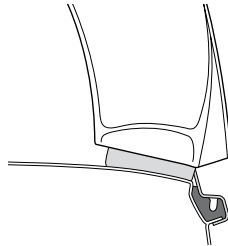
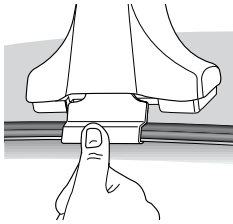
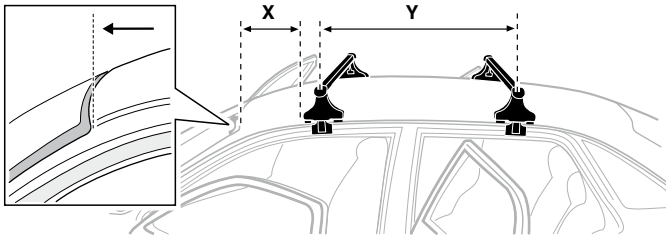

GB/US Tighten alternately

D Die Schrauben abwechselnd anziehen

F Serrer alternativement chaque côté

NL Afwisselend aan de linker- en de rechterkant aandraaien

I Alternare il serraggio delle viti

E Apertar alternativamente

PT Aperte alternadamente

S Dra åt växelvis

FIN Kierrä vuorotellen

EST Pinguldage vaheldumisi

LAT Pielvelciet pamišus

LIT Užsukinėkite pakaitomis

PL Śruby dokręcaj naprzemiennie

RU Затягивайте попеременно

CZ Pokręťta bagażníka dokręcaj dokręcaj naprzemiennie.

SK Doťahujte striedavo

SLO Privijajte izmenično.

HR Naizmjenično zategnite

HU Egymástól függetlenül szorítandó

GR Σφίγγετε εναλλάξ

TR Dönüşümlü sıkın

中文 交替拧紧

한국어 번갈아 가며 조이십시오.

日本語 交互に締め付けてください。

ไทย ชั้้นในแบบสลับ

6



480R/754



480



*
3 Nm



*



*
≈ 3 Nm

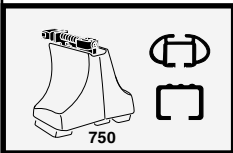
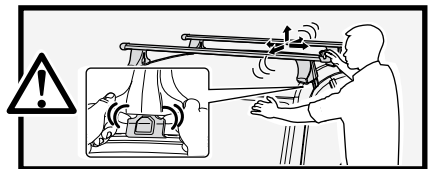

750

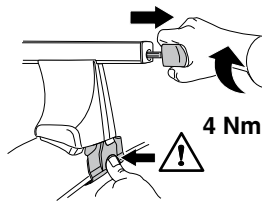

4 Nm

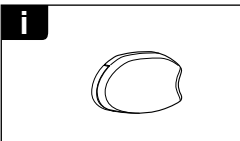
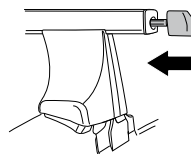

i

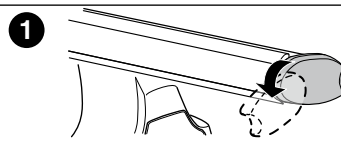

1

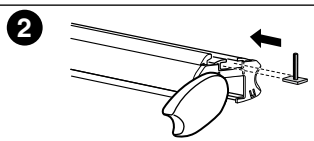

2

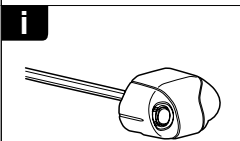

i

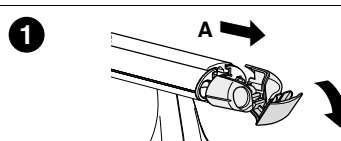

1

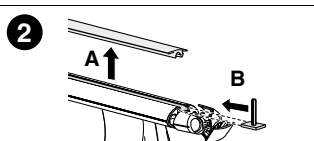

2

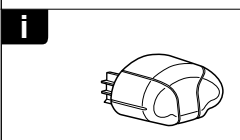

i

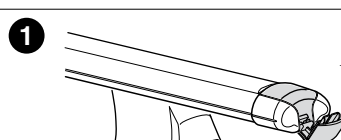

1

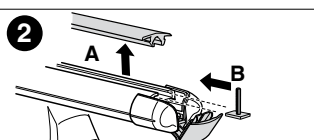

2



THULE
SWEDEN
**ONE
KEY
SYSTEM**

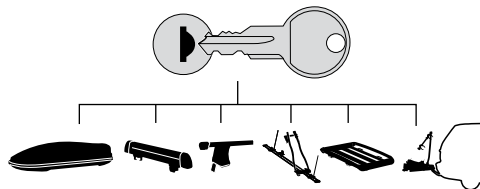

- 544 (x4)
- 596 (x6)
- 588 (x8)
- NA 510 (x10)
- EUR 452 (x12)
- ASIA

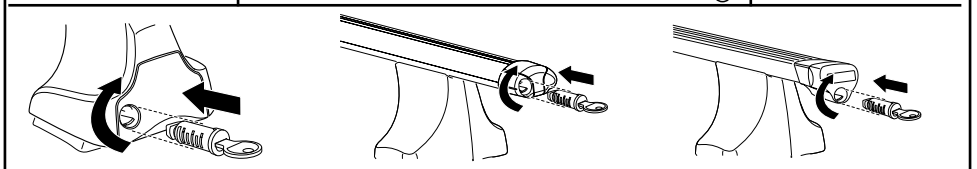

WW ▶ Thule Sweden AB, Box 69, 330 33 Hillerstorp, SWEDEN
NA ▶ Thule Inc., 42 Silvermine Road, Seymour, Connecticut 06483, USA

info@thule.com
customer.service@thule.com

www.thule.com