

Kit 1385

TOYOTA Rav 4 (Mk.III.), 5-dr SUV, 05-09, 10-
TOYOTA Vanguard, 5-dr SUV, 07-

480R
754

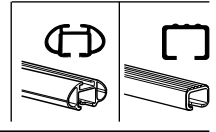
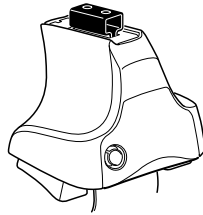

480

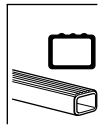
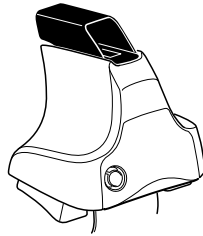

750

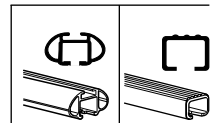
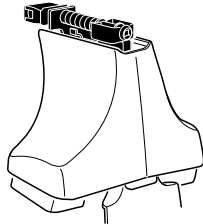

Kit

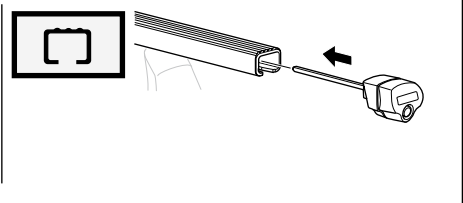
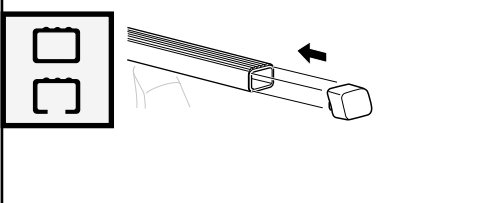
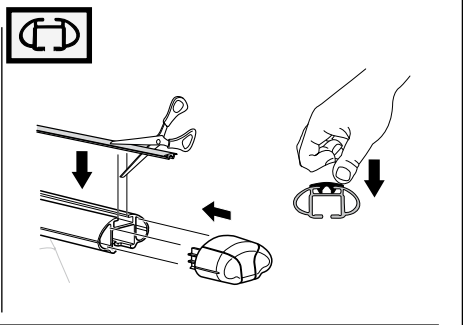
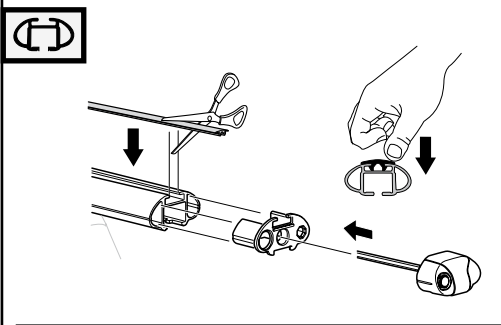
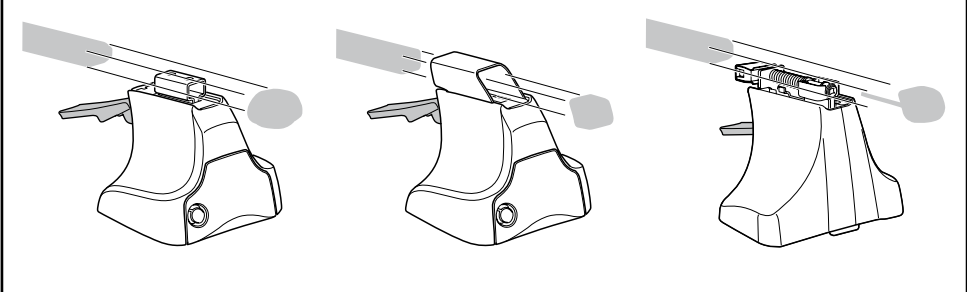
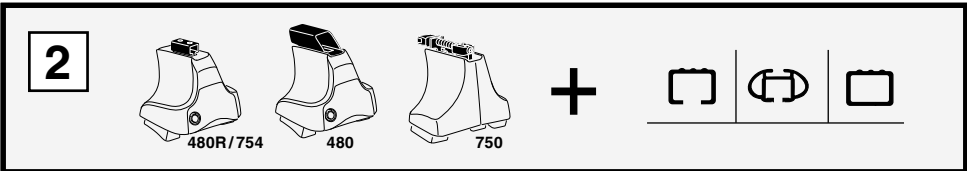
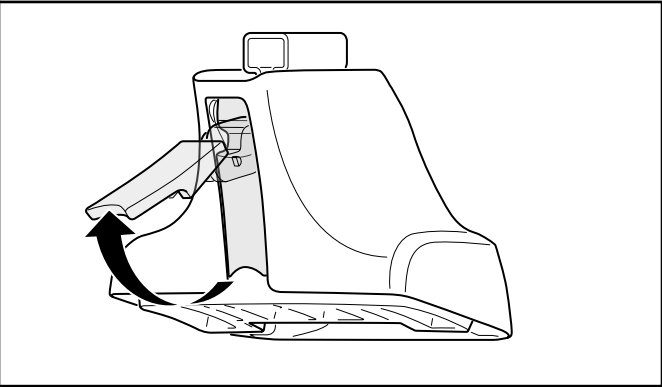
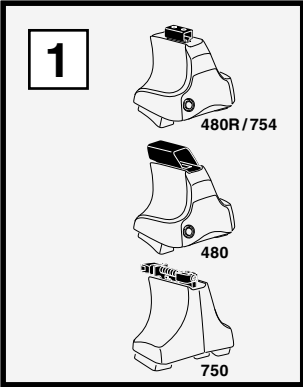

3

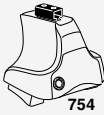

754



750

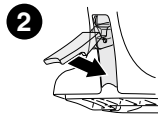
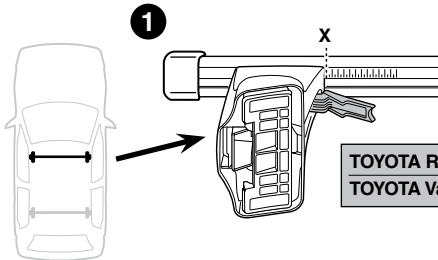

	X
TOYOTA Rav 4 (Mk.III.), 5-dr SUV, 05-09, 10-	40
TOYOTA Vanguard, 5-dr SUV, 07-	40

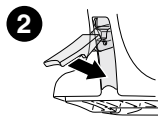
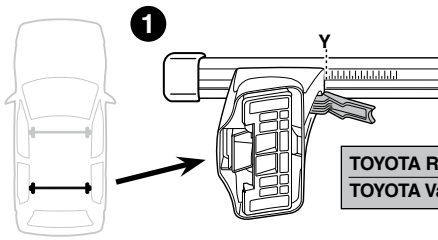

	Y
TOYOTA Rav 4 (Mk.III.), 5-dr SUV, 05-09, 10-	36
TOYOTA Vanguard, 5-dr SUV, 07-	36



480R



480

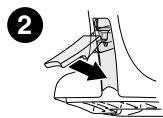
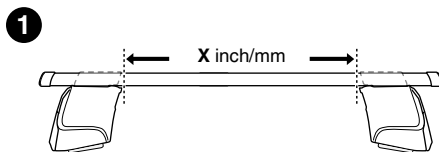

	X inch	X mm
TOYOTA Rav 4 (Mk.III.), 5-dr SUV, 05-09, 10-	41 ³ / ₈ "	1051 mm
TOYOTA Vanguard, 5-dr SUV, 07-	41 ³ / ₈ "	1051 mm

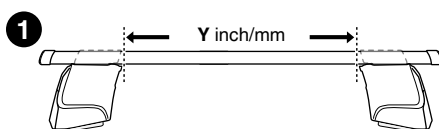
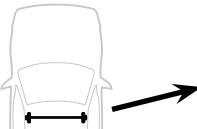

	Y inch	Y mm
TOYOTA Rav 4 (Mk.III.), 5-dr SUV, 05-09, 10-	39 ³ / ₄ "	1011 mm
TOYOTA Vanguard, 5-dr SUV, 07-	39 ³ / ₄ "	1011 mm

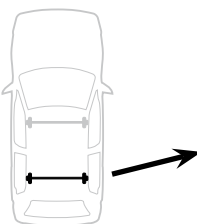

4

TOYOTA Rav 4 (Mk.III.), 5-dr SUV, 05-09, 10-
TOYOTA Vanguard, 5-dr SUV, 07-

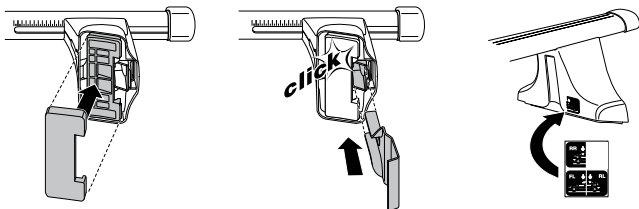
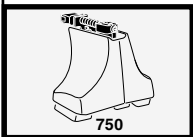
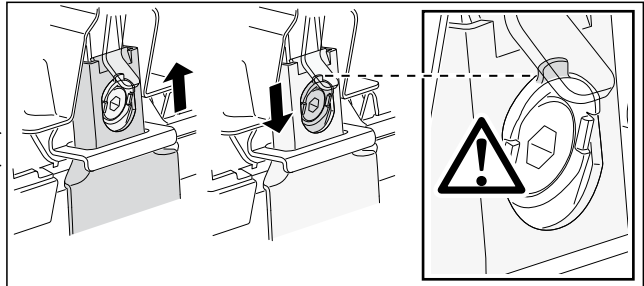
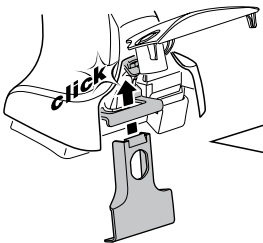
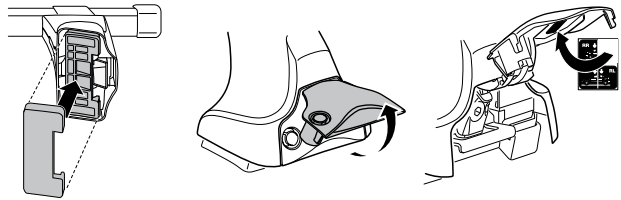
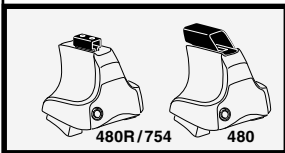
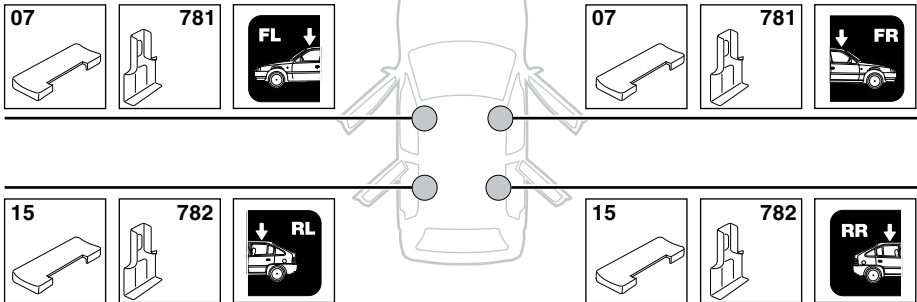

5



	X mm	Y mm	X inch	Y inch
TOYOTA Rav 4 (Mk.III.), 5-dr SUV, 05-09, 10-	470 mm	710 mm	18 1/2"	28"
TOYOTA Vanguard, 5-dr SUV, 07-	470 mm	710 mm	18 1/2"	28"

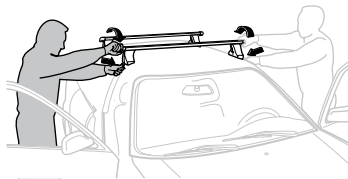
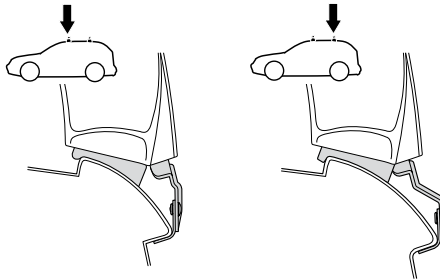
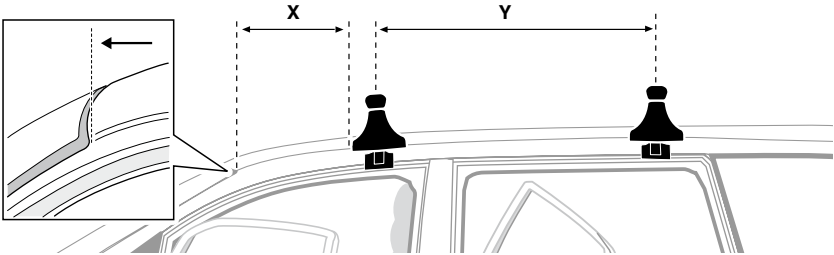

GB/US Tighten alternately

D Die Schrauben abwechselnd anziehen

F Serrer alternativement chaque côté

NL Afwisselend aan de linker- en de rechterkant aandraaien

I Alternare il serraggio delle viti

E Apertar alternativamente

PT Aperte alternadamente

S Dra åt växelvis

FIN Kierrä vuorotellen

EST Pinguldage vaheldumisi

LAT Pielvelciēt pamīšus

LIT Užsukinėkite pakaitomis

PL Śruby dokręcaj naprzemiennie

RU Затягивайте попеременно

CZ Pokręťta bagażníka dokręcaj dokręcaj naprzemiennie.

SK Doťahujte striedavo

SLO Privijajte izmenično.

HR Naizmjenično zategnite

HU Egymástól függetlenül szorítandó

GR Σφίγγετε εναλλάξ

TR Dönüşümlü sıkın

中文 交替拧紧

한국어 번갈아 가며 조이십시오.

日本語 交互に締め付けてください。

ไทย ชั้้นในแบบสลับ

6



480R/754



480

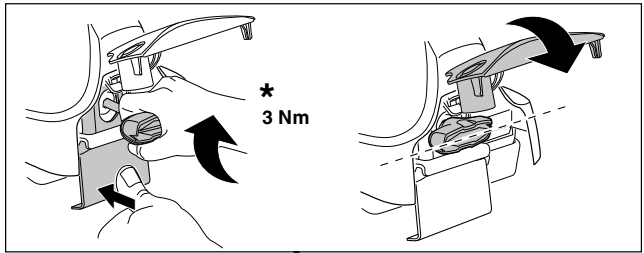
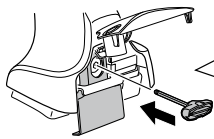

*
3 Nm

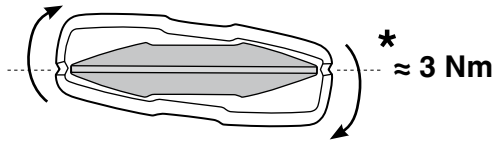
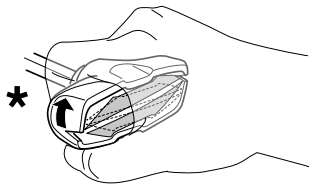

*
≈ 3 Nm

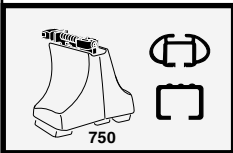
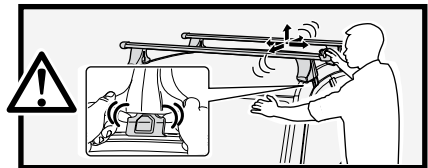

750

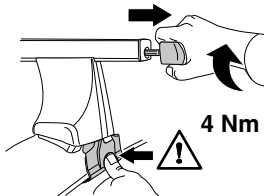

4 Nm

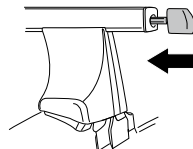

7



x1
17 mm

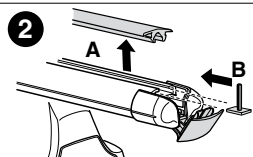
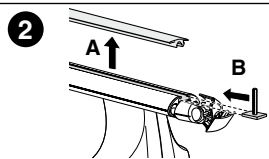
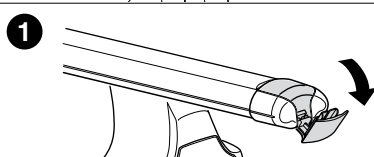
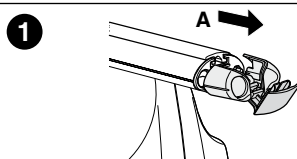
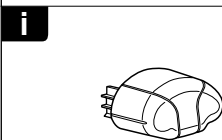
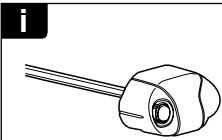
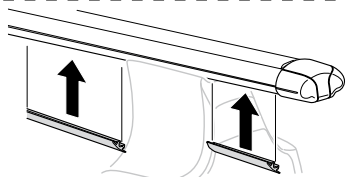



THULE
SWEDEN
**ONE
KEY
SYSTEM**



- 544 (x4)
- 596 (x6)
- 588 (x8)
- NA 510 (x10)
- EUR 452 (x12)
- ASIA 452 (x12)



WW ▶ Thule Sweden AB, Box 69, 330 33 Hillerstorp, SWEDEN
NA ▶ Thule Inc., 42 Silvermine Road, Seymour, Connecticut 06483, USA

info@thule.com
customer.service@thule.com

www.thule.com