

# Kit 3034

- VOLKSWAGEN California (T5)**, 4-dr Bus, 03-09, 10-
- VOLKSWAGEN Caravelle (T5)**, 4-dr Bus, 03-09, 10-
- VOLKSWAGEN Multivan (T5)**, 4-dr Bus, 03-09, 10-
- VOLKSWAGEN Shuttle (T5)**, 4-dr Bus, 03-09, 10-
- VOLKSWAGEN Transporter (T5)**, 2-dr Single Cab, 03-09, 10-
- VOLKSWAGEN Transporter (T5)**, 4-dr Double Cab, 03-09, 10-
- VOLKSWAGEN Transporter (T5)**, 4-dr Van, 03-09, 10-

This Kit is only for vehicles with fixpoint mounting or T-profile.

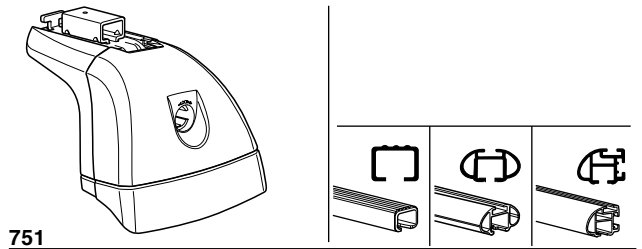

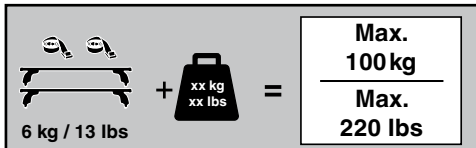

6 kg / 13 lbs + xx kg xx lbs = **Max. 100 kg**  
**Max. 220 lbs**

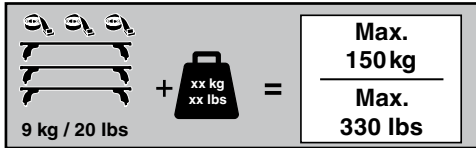

9 kg / 20 lbs + xx kg xx lbs = **Max. 150 kg**  
**Max. 330 lbs**

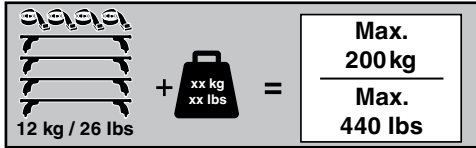

12 kg / 26 lbs + xx kg xx lbs = **Max. 200 kg**  
**Max. 440 lbs**

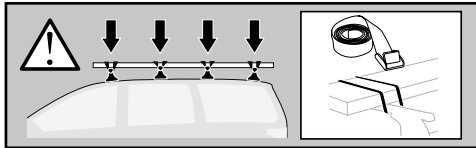
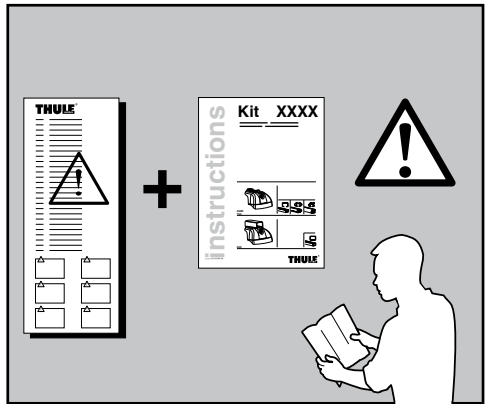
THULE + Kit XXXX + **!**

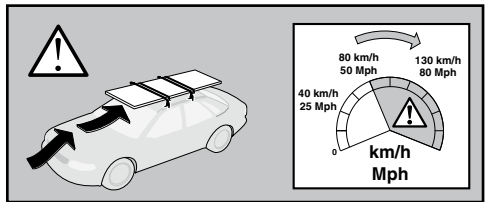

**!**

80 km/h 130 km/h  
50 Mph 80 Mph

40 km/h 25 Mph

**km/h**  
**Mph**

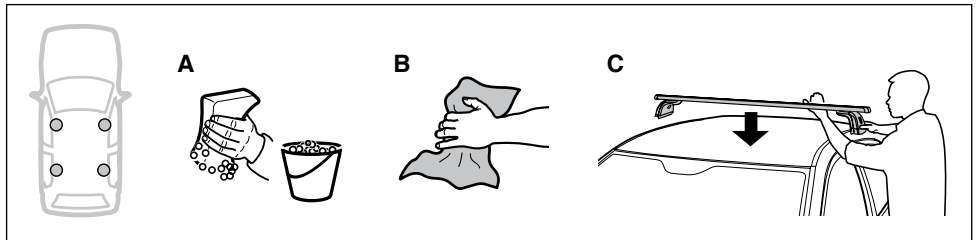

**A** **B** **C**

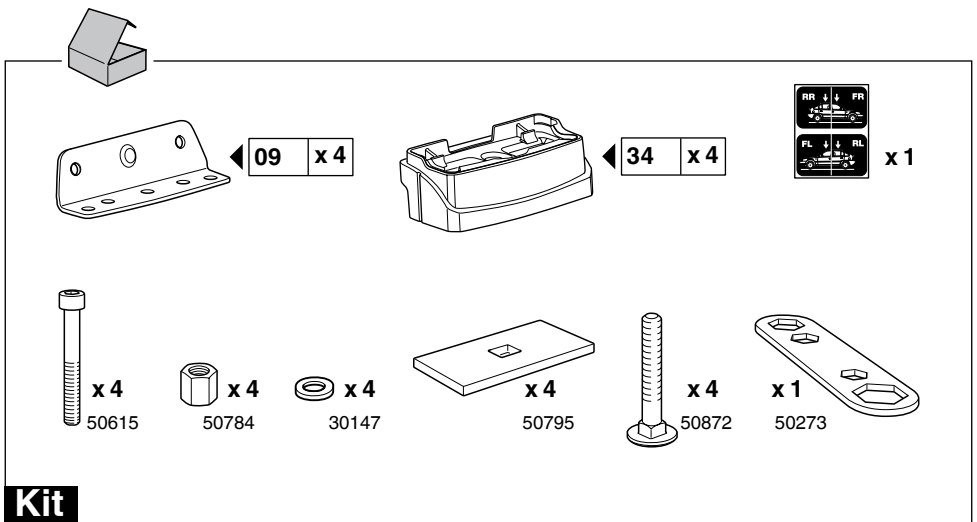

**Kit**

09 x 4

34 x 4

50615 x 4

50784 x 4

30147 x 4

50795 x 4

50872 x 4

50273 x 1

RR ↓ ↓ FR  
FL ↓ ↓ RL

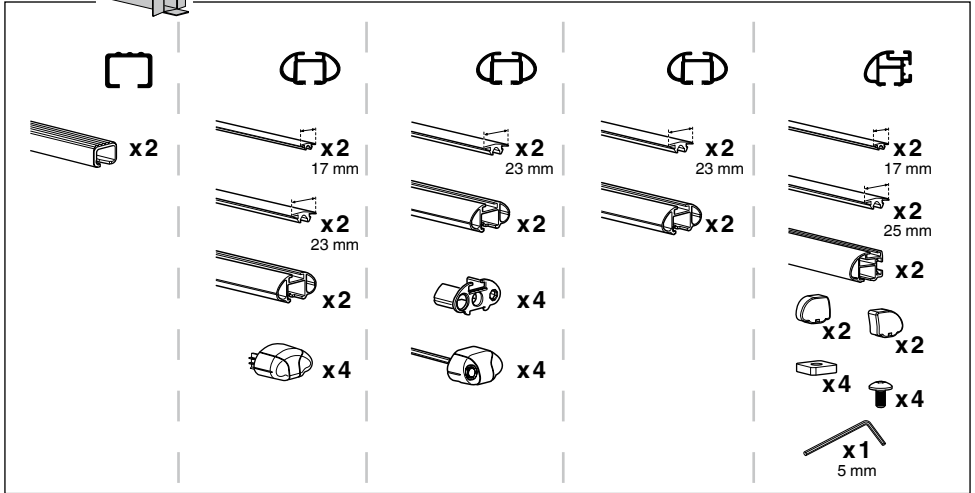
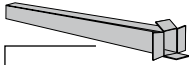
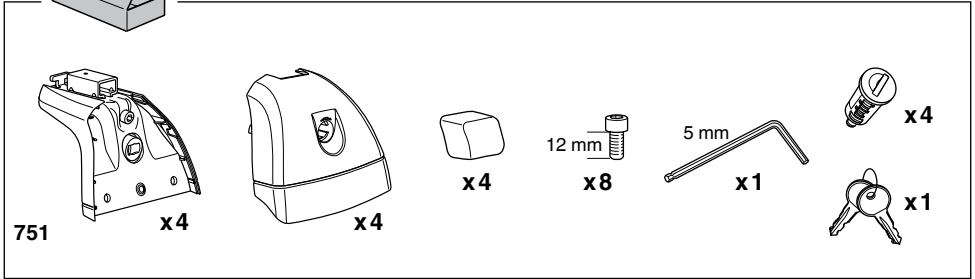

1

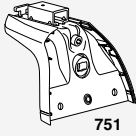

751

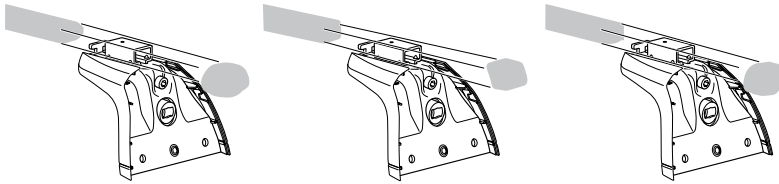

x4

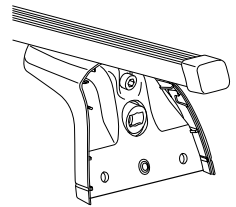
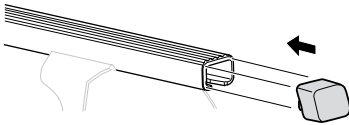

x4

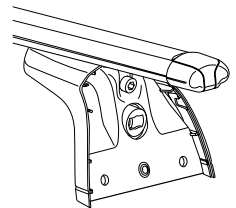
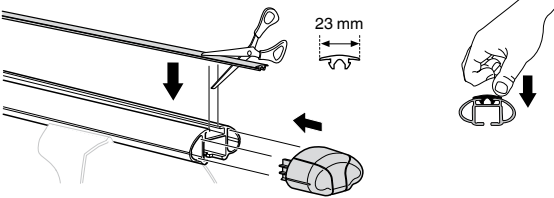

x4

x4

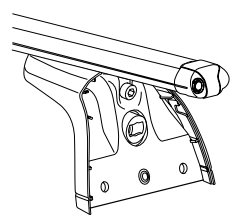
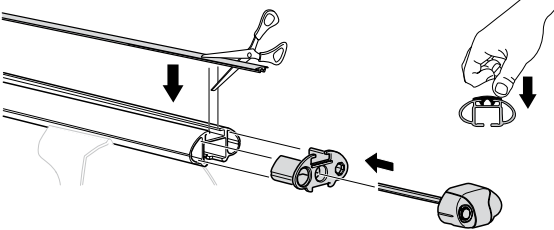

x2

x2

x4

x4

x1

5 mm

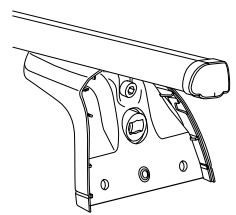
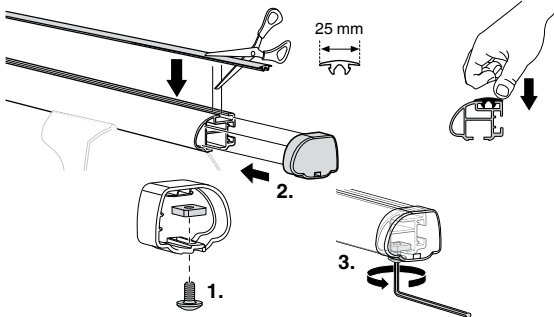

2

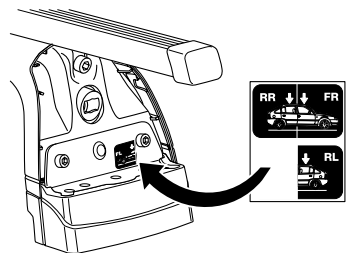
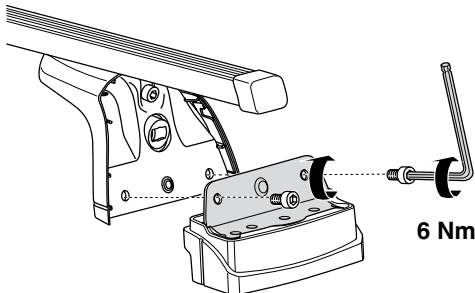
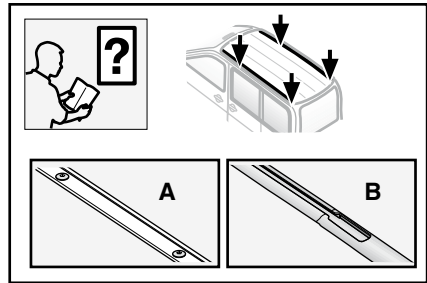
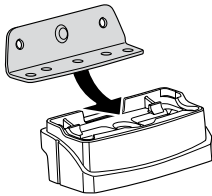
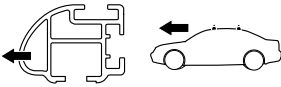
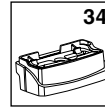
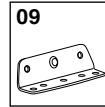
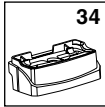
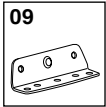
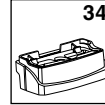
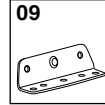
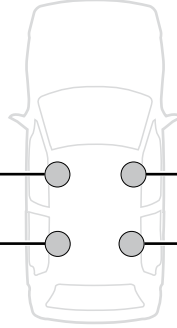
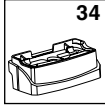
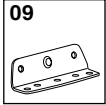
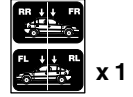
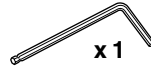
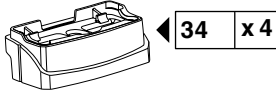
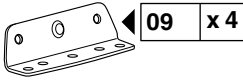

**3**



x4



x4

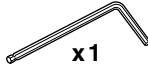

x1

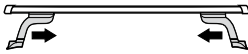
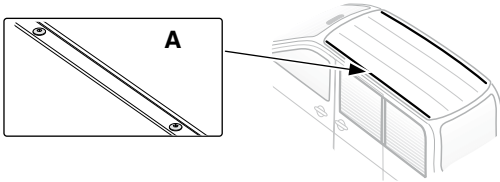
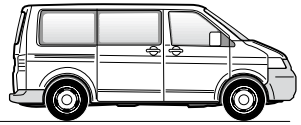
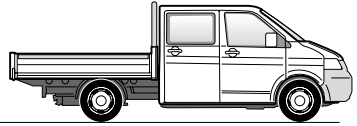
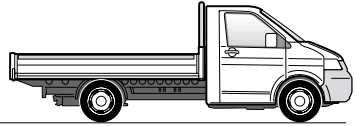

**A**

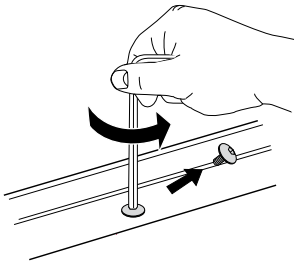

**B**

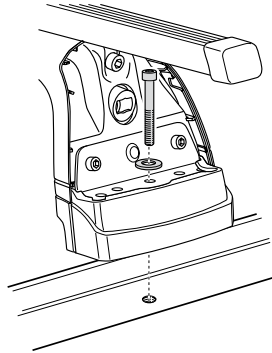

**C**

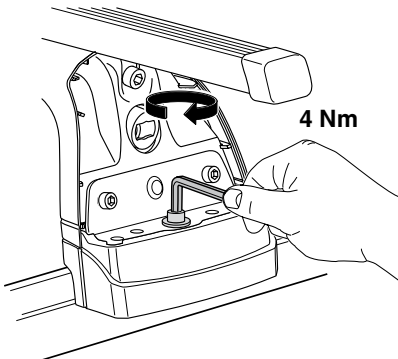

**D**

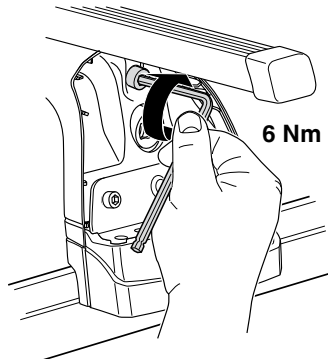

**3**

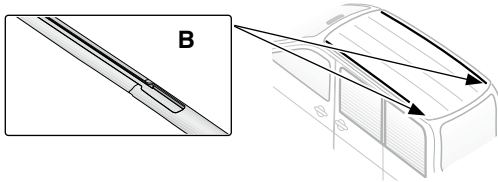
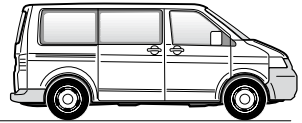
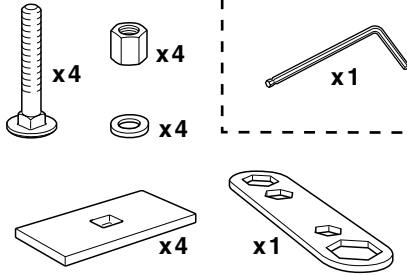

**A**

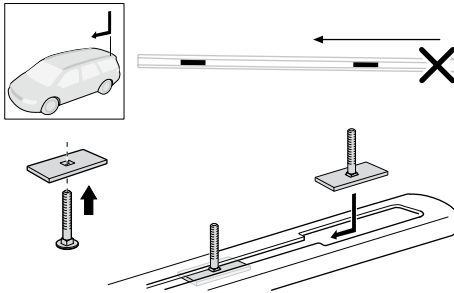

**B**

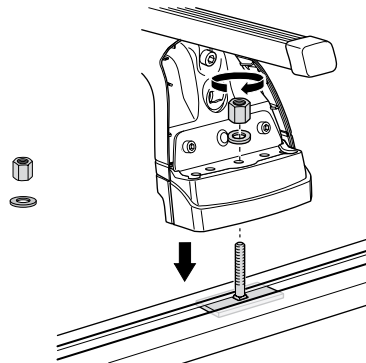

**C**

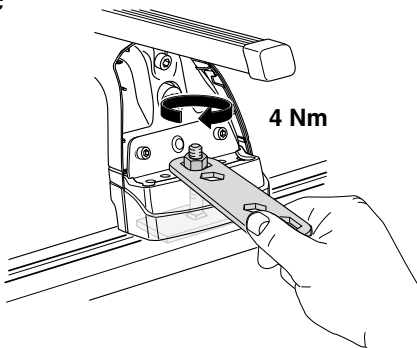

**D**

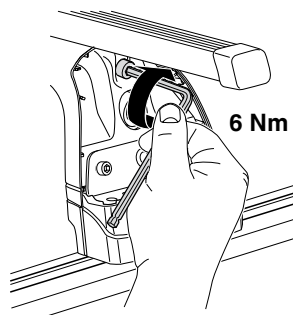

**4**

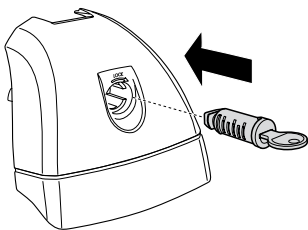

**5**

5 mm

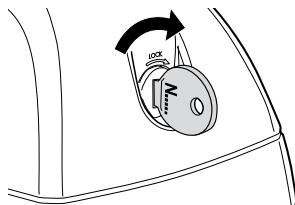
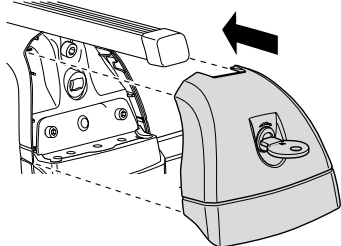
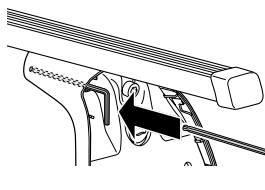

**6**

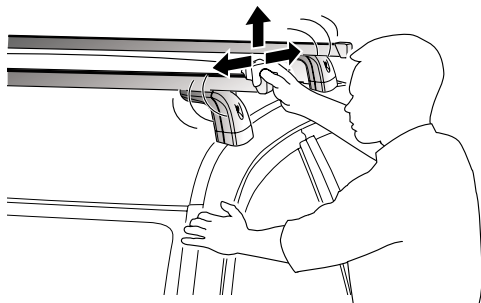



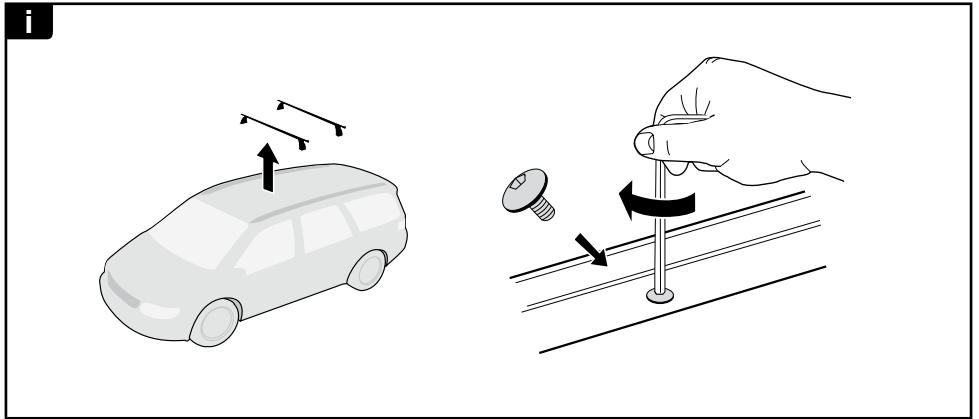
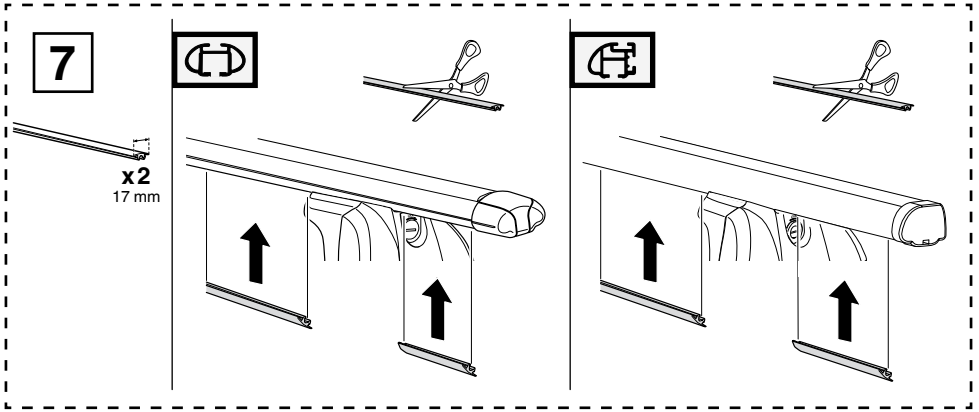





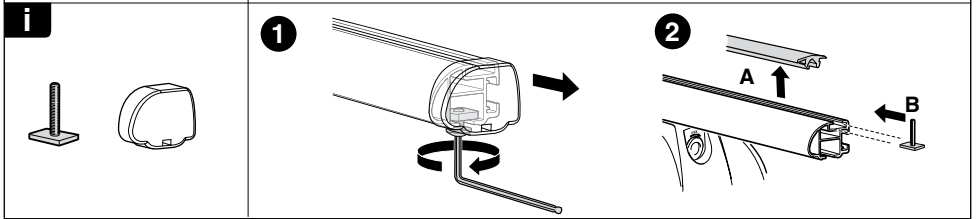
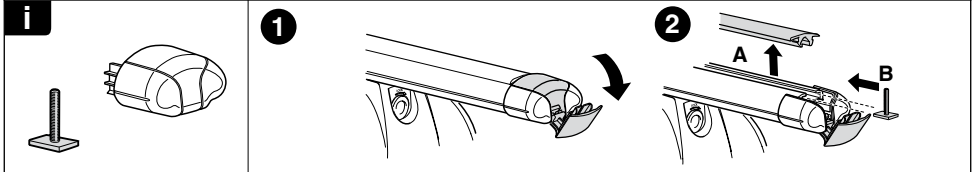
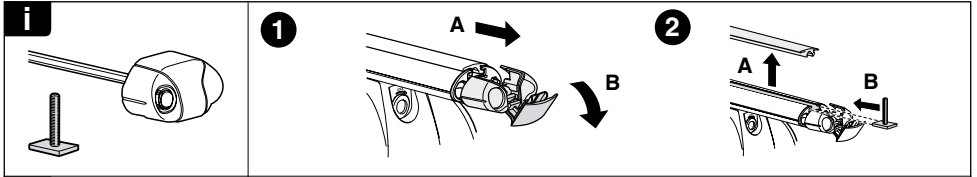
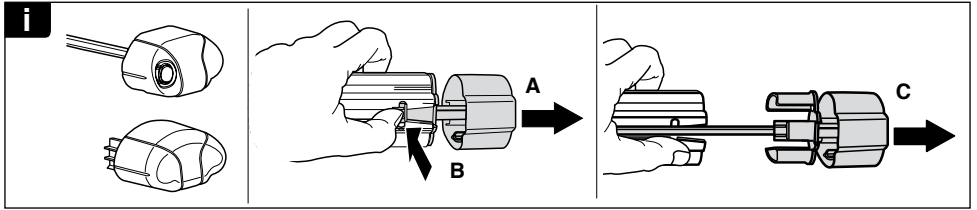



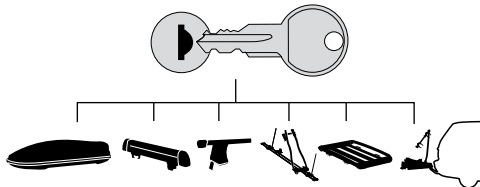



**THULE**  
SWEDEN  
**ONE  
KEY  
SYSTEM**



-  **544** (x4)
  -  **596** (x6)
  -  **588** (x8)
  -  **510** (x10)
  -  **452** (x12)
- NA  
EUR  
ASIA